

LED Indicator Signs



Good visibility – for more safety

Indicator Signs are an important means of providing safety information for the passengers.

Integrated in the passenger service units above the seats, in walls and ceilings of galleys and lavatories, they may show clear and easily recognizable symbols with different intentions.

For example, Indicator Signs can tell the passengers to return to their seats, to fasten their seat belts or to turn off electronic devices.

Wide range of options

UTC Aerospace Systems offers a wide range of Indicator Signs. Different sizes, panel and light colors and a variety of prints are options to choose from. Using state-of-the-art LED technology, they feature a long lifetime up to 80,000 operating hours, low power consumption, low maintenance effort, high resistance to shock and vibration and room temperature at touchable parts.

Modern aircraft interiors require lighting equipment with a plain design and unobtrusive appearance. UTC Aerospace Systems' latest Indicator Signs feature a smooth panel easy to integrate into a smooth surface. They are mounted by clipping which simplifies the handling. Thanks to a patented production method, these signs only show their symbols during light operation.

Experience

UTC Aerospace Systems has more than 20 years of experience in the use of LED technology and was the first to develop an LED reading light for series production in aircraft.

Since then, the company has produced more than 500,000 lights – always focusing research into providing lighting systems that promote the highest levels of passenger comfort.



LED Indicator Signs

2LA007344-XX

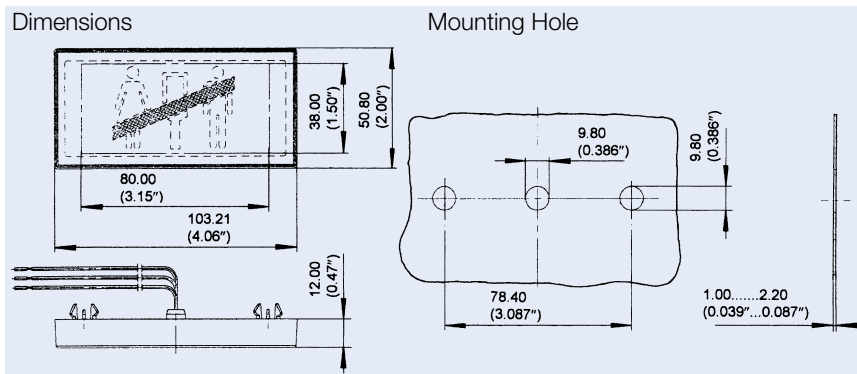

Technical Data:

- Operating Voltage: see variant table
- Operating Current: see variant table
- Lifetime of LEDs: 30,000 h
- Light Color: Yellow; symbols only visible during light operation (except -50, -60, -80, -85)
- Luminance: see variant table
- Color of Housing: Cloud Grey
- Color of Front Panel: Cloud Grey
- Connection: flying leads
3 x 500 mm/19.685"
(-26: with connector)
- Weight: 0.050 kg/0.110 lbs max.
(-26: 0.052 kg/0.115 lbs max.)

Print	Part-Number	Operating Voltage	Operating Current	Luminance
	-00	28 V DC	2 x 26 mA ± 15 %	80 cd/m ² min.
	-05	28 V DC	2 x 47 mA ± 15 %	80 cd/m ² min.
	-08	28 V DC	2 x 26 mA ± 15 %	80 cd/m ² min.
	-09	28 V DC	2 x 26 mA ± 15 %	80 cd/m ² min.
	-10	28 V DC	2 x 47 mA ± 15 %	80 cd/m ² min.
	-15	28 V DC	2 x 47 mA ± 15 %	80 cd/m ² min.
	-25	28 V DC	2 x 26 mA ± 15 %	80 cd/m ² min.
	-26	28 V DC	2 x 26 mA ± 15 %	50 cd/m ² min.
	-35	28 V DC	2 x 47 mA ± 15 %	80 cd/m ² min.
	-50	28 V DC	2 x 26 mA ± 15 %	80 cd/m ² min.
	-60	6 V DC	390 mA ± 15 %	60 cd/m ² min.
	-80	6 V DC	390 mA ± 15 %	60 cd/m ² min.
	-85	6 V DC	390 mA ± 15 %	60 cd/m ² min.

Further variants available on request.

LED Indicator Signs

2LA455173-XX

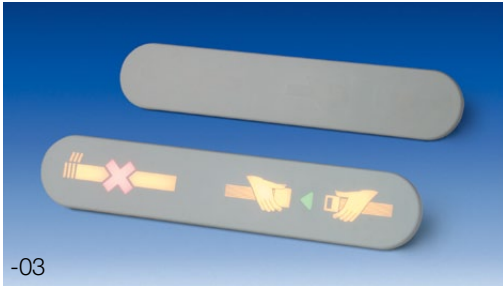

-03

Technical Data:

- Operating Voltage: 22 – 30 V DC
- Operating Current: 50 mA ± 20 %
- Lifetime of LEDs: 80,000 h
- Average Luminance: 70 cd/m²
- Connection: 3 contacts mating connector AMP 170324-2
- Weight: 0.038 kg/0.084 lbs max.

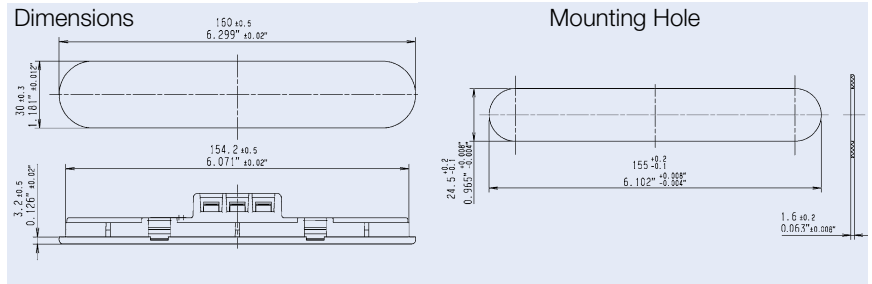

Print	Illumi- nation	Dream Grey	White	Stone Grey	Fog	Porce- lain	Pepper- dust
	Yellow	-30	-31	-32	-33	-34	-35
	Yellow	-20	-21	-22	-23	-24	-25
	Yellow	-10	-11	-12	-13	-14	-15
	Yellow	-00	-01	-02	-03	-04	-05

Further front panel colors available on request.

2LA455924-XX



-13

Technical Data:

same as 2LA455173-XX above except

- Operating Current: 40 mA ± 20 %

Print	Illumi- nation	Stone Grey	Fog	Porce- lain	Pepper- dust
	White	-32	-33	-34	-35
	White	-22	-23	-24	-25
	White	-12	-13	-14	-15
	White	-02	-03	-04	-05

Further front panel colors available on request.
Dimensions and Mounting Hole same as 2LA455173-XX above.

2LA455976-XX



-23

Technical Data:

- Operating Voltage: 22 – 30 V DC
- Operating Current: 40 mA ± 20 %
- Lifetime of LEDs: 80,000 h

Print	Illumi- nation	Dream Grey	White	Stone Grey	Fog	Porce- lain	Pepper- dust
	White	-20	-21	-22	-23	-24	-25
	White	-10	-11	-12	-13	-14	-15
	Yellow	-00	-01	-02	-03	-04	-05

Further front panel colors available on request.
Dimensions and Mounting Hole same as 2LA455173-XX above.

- Average Luminance White: 70 cd/m²
- Average Luminance Yellow: 45 cd/m²
- Connection: 3 contacts mating connector AMP 170324-2
- Weight: 0.04 kg/0.088 lbs max.

LED Indicator Signs

2LA456276-XX



-03

Technical Data:

- Operating Voltage: 22 – 30 V DC
- Operating Current: 40 mA ± 20 %
- Lifetime of LEDs: 80,000 h
- Average Luminance: 70 cd/m²
- Connection: 3 contacts mating connector AMP 170324-2
- Weight: 0.04 kg/0.088 lbs max.

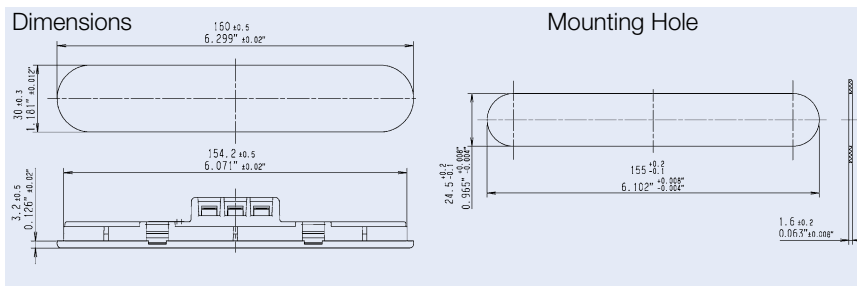

Print	Illumi- nation	Dream Grey	White	Stone Grey	Fog	Porce- lain	Pepper- dust
	White	-10	-11	-12	-13	-14	-15
	White	-00	-01	-02	-03	-04	-05

2LA456600-XX



-03

Technical Data:

- Operating Voltage: 22 – 30 V DC
- Operating Current: 40 mA ± 20 %
- Lifetime of LEDs: 80,000 h
- Average Luminance: 70 cd/m²
- Connection: 3 contacts mating connector AMP 170324-2
- Weight: 0.038 kg/0.084 lbs max.

Print	Illumi- nation	Dream Grey	White	Stone Grey	Fog	Porce- lain	Pepper- dust
	White	-10	-11	-12	-13	-14	-15
	White	-00	-01	-02	-03	-04	-05

Dimensions and Mounting Hole same as 2LA456276-XX above.

2LA456601-XX



-05

Technical Data:

- Operating Voltage: 22 – 30 V DC
- Operating Current: 50 mA ± 20 %
- Lifetime of LEDs: 80,000 h
- Average Luminance: 70 cd/m²
- Connection: 3 contacts mating connector AMP 170324-2
- Weight: 0.04 kg/0.088 lbs max.

Print	Illumi- nation	Dream Grey	White	Stone Grey	Fog	Porce- lain	Pepper- dust
	White	-00	-01	-02	-03	-04	-05

Further front panel colors available on request.
Dimensions and Mounting Hole same as 2LA456276-XX above.

LED Indicator Signs

2LA455627-XX

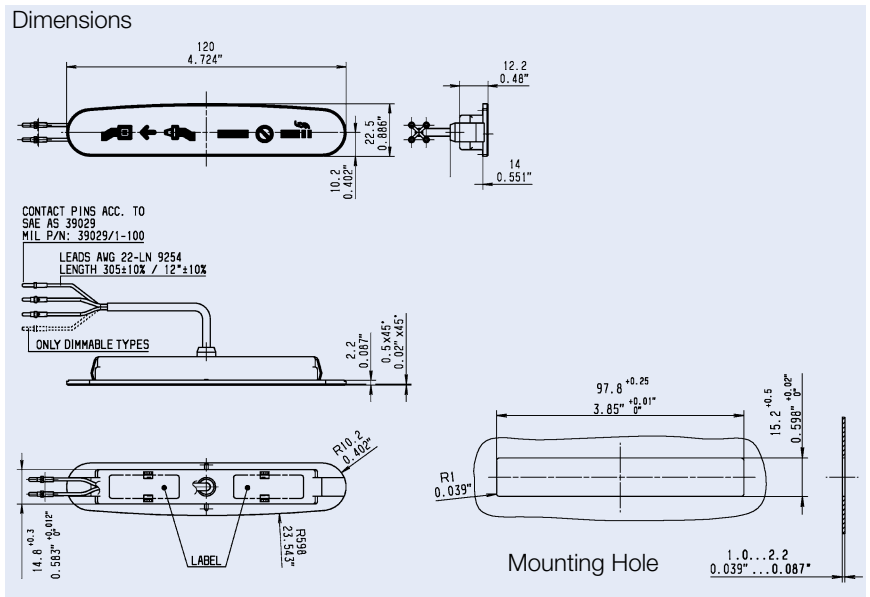
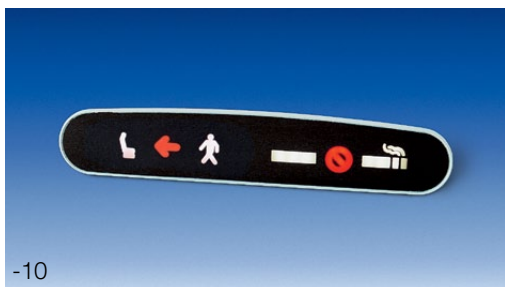

Technical Data:

- Operating Voltage: 28 V DC
- Operating Current: 45 mA ± 20 %
- Lifetime of LEDs: 20,000 h
- Light Color: White
- Luminance: 60 cd/m² min.
- Dimmability: see variant table
- Color of Housing/Front Panel: see variant table
- Connection: with Contact Pins
- Weight: see variant table

Print	Part-Number	Color of Housing/Panel	Dimmability	Weight (max.)
	-00	Light Grey/Dark Brown	No	0.030 kg/0.066 lbs
	-10	Light Grey/Dark Brown	No	0.030 kg/0.066 lbs
	-20	Beige	No	0.030 kg/0.066 lbs
	-30	Beige	No	0.030 kg/0.066 lbs
	-40	Dark Brown	No	0.030 kg/0.066 lbs
	-50	Dark Brown	No	0.030 kg/0.066 lbs
	-01	Beige	Yes	0.034 kg/0.075 lbs
	-11	Dark Brown	Yes	0.034 kg/0.075 lbs
	-41	Brown Beige	Yes	0.034 kg/0.075 lbs
	-51	Brown Beige	Yes	0.034 kg/0.075 lbs
	-61	Yellowish Beige	Yes	0.034 kg/0.075 lbs
	-71	Yellowish Beige	Yes	0.034 kg/0.075 lbs

LED Indicator Signs

2LA007353-XX

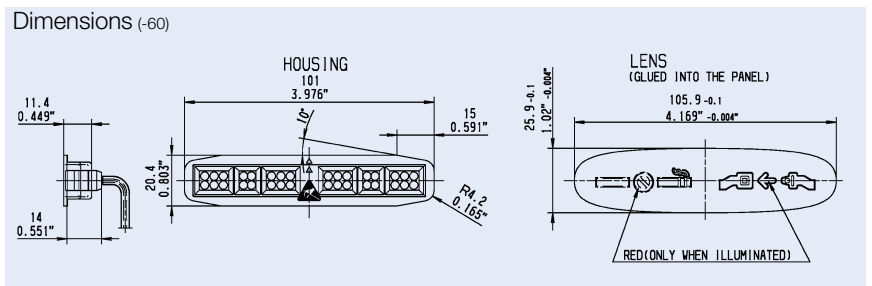
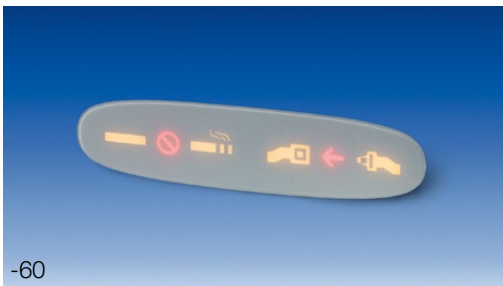
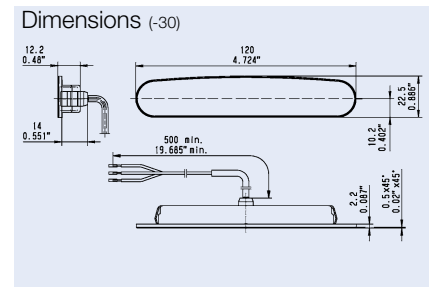
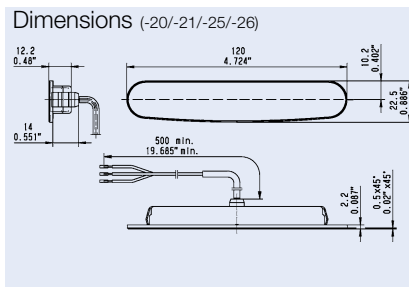
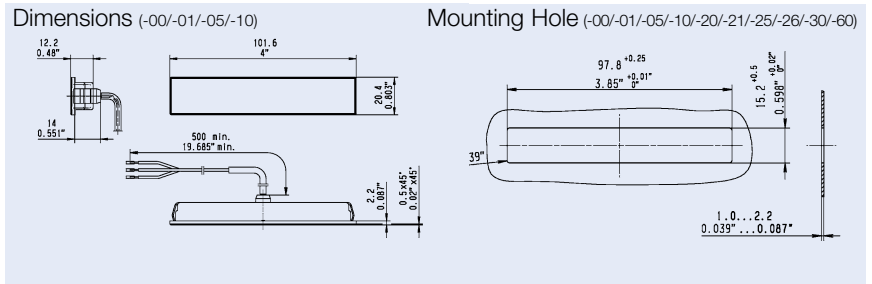

Technical Data:

- Operating Voltage: 28 V DC
- Operating Current: 2 x 16 mA ± 20 %
- Lifetime of LEDs: 20,000 h
- Light Color: Yellow
- Luminance: 120 cd/m² min.
- Color of Housing/Front Panel: see variant table
- Connection: see variant table
- Weight: see variant table

Print	Part-Number	Color of Housing/Panel	Weight (max.)	Connection*
	-00	Light Grey/Grey	0.025 kg/0.055 lbs	Flying Leads
	-05	Light Grey/Grey	0.025 kg/0.055 lbs	Contact Pins
	-10	Light Grey/Dark Brown	0.025 kg/0.055 lbs	Flying Leads
	-20	Light Grey/White	0.035 kg/0.077 lbs	Contact Pins
	-21	Light Grey/White	0.035 kg/0.077 lbs	Connector
	-25	Light Grey/White	0.040 kg/0.088 lbs	Connector
	-26	Light Grey/White	0.035 kg/0.077 lbs	Contact Pins
	-30	Light Grey/White	0.040 kg/0.088 lbs	Connector
	-60	Light Grey/Light Grey	0.035 kg/0.077 lbs	Contact Pins

*Further information available on request.

2LA007353-01



Technical Data:

- Operating Voltage: 6 V DC
- Operating Current: 135 mA ± 25 %
- Lifetime of LEDs: 20,000 h
- Light Color: White
- Luminance: 60 cd/m² min.
- Color of Housing: Light Grey
- Color of Front Panel: Grey
- Connection: Flying Leads
3 x 127 mm/5" ± 10%
- Weight: 0.035 kg/0.077 lbs max.
- Dimension and Mounting Hole same as 2LA007363-00

LED Indicator Signs

2LA007353-XX

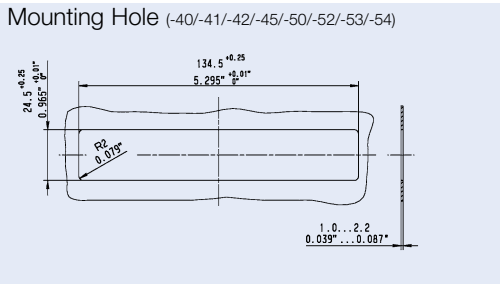
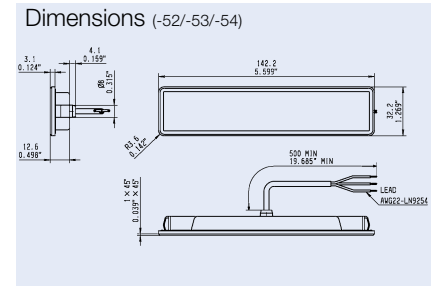
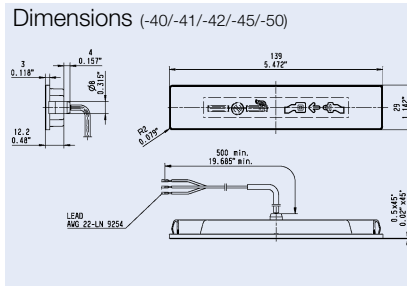
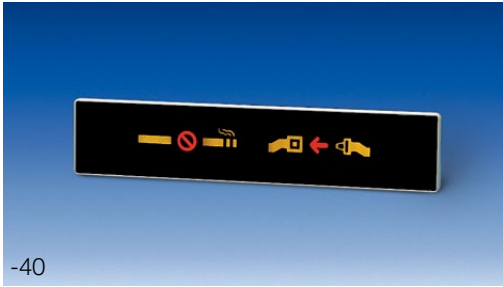

Technical Data:

- Operating Voltage: 28 V DC
- Operating Current: 2 x 16 mA ± 20 %
- Lifetime of LEDs: 20,000 h
- Light Color: Yellow
- Luminance: 120 cd/m² min.
- Color of Housing/Front Panel: see variant table
- Connection: see variant table
- Weight: see variant table

Print	Part-Number	Color of Housing/Panel	Weight (max.)	Connection*
	-40	Light Grey/Dark Brown	0.038 kg/0.084 lbs	Flying Leads
	-41	Light Grey/Dark Brown	0.038 kg/0.084 lbs	Contact Pins
	-42	Light Grey/Dark Brown	0.038 kg/0.084 lbs	Contact Pins
	-45	Light Grey/Dark Brown	0.036 kg/0.079 lbs	Contact Pins
	-50	Light Grey/Dark Brown	0.044 kg/0.097 lbs	Connector
	-52	Light Grey/Dark Brown	0.060 kg/0.132 lbs	Flying Leads
	-53	Light Grey/Cream	0.060 kg/0.132 lbs	Flying Leads
	-54	Light Grey/Cream	0.060 kg/0.132 lbs	Flying Leads

*Further information available on request.

This document does not contain any export controlled technical data.

For additional information:
 Goodrich Lighting Systems GmbH
 a UTC Aerospace Systems company
 Bertramstrasse 8
 59557 Lippstadt/Germany
 Tel.: +49 2941 7676 0
 Fax: +49 2941 7676 8432
 www.utcaerospace.com